

Golden Island

by TAB-Austria

GOLDEN ISLAND NEVADA

Manual



➔ Better games through innovation



TAB-Austria GmbH & CoKG

Haider Strasse 40, 4052 Ansfelden, Austria,
Phone +43 (0) 7229 78040, Fax +43 (0) 7229 78660,
E-Mail: sales@tab.at, www.tab.at

Hotline: +43 (0) 7229 78040-250, E-Mail: hotline@tab.at

We thank you for choosing

Golden Island Nevada

We recommend you, for a satisfactory use of your Golden Island Nevada, that you read the manual exactly.

We wish you much success and much joy with your Golden Island Nevada.

Please store this manual in such a way as to make it readily at hand if so required.

For additional queries, our Hotline is at your service.

Call: +43 (0) 7229 78040 250

E-Mail: hotline@tab.at

Your TAB-Austria Team

Technical Info *Golden Island Nevada Manual*

More information on the page:

<http://www.tab.at/download>

(WS, 9th September 2010)

The text passages and illustrations contained within this document were put together with the greatest amount of care and attention, however, mistakes cannot be completely ruled out.

The manufacturer accepts no legal responsibility or liability in any form with regard to errors in detail, and any consequences that may arise from such errors.

The manufacturer is thankful for any suggestions for improvement or pointers leading to errors.

All rights - including any arising from photomechanical reproduction and storage in electronic or any other medium - are reserved. The program, handbook, and all components are subject to international copyright regulations.

Haider Strasse 40, 4052 Ansfelden, Austria

Phone +43 (0) 7229 78040, Fax +43 (0) 7229 78660

All rights reserved.



Modification History:

11.11.2008 First Revision

08.01.2009 V2.01

22.01.2009 V2.03: additions for OTM

16.03.2009 V2.02 and V2.04: additions for maintenance of printer and coin and note acceptor; changes in operator mode for hopper statistics, refill and revision

10.06.2009 V2.07: new game Aloha Hawaii; machine serial number will be read from cctalk dongle

25.06.2009 V2.10: new game Hot Fruits; separate machine accounting for supervisor

10.11.2009 V2.13: Network settings

11.03.2010 V2.20: TITO by OTM server; new games Secrets of Maya and Bingo

03.09.2010 V2.22: new OTM registration

03.09.2010 V2.22: new game Mystic Ocean



Contents

Contents	iii
1 Safety Information	1
2 Description	5
2.1 General	5
2.2 System components	5
Options	5
PC System	5
2.3 Operating Elements	6
3 Technical Data	7
3.1 Machine dimensions	7
3.2 Electrical Data	7
4 Initial Operation	9
5 Boot Up menu by activated test switch	11
6 Update process	13
7 Info Page	15
8 Service Menu	17
9 Configuration settings	19
9.1 Basic Settings	19
Languages	19
Date / Time	19
Security	20
Machine ID	20
9.2 Game + Limit Settings	21
Games	21
Limits	21
Hopper Limits	21
9.3 Function Assignment	22
9.4 Hardware Settings	22
Coin acceptor	22
Note acceptor	22
Remote / Collect	22
Hopper	23
Ticket Printer	23
Mechanical Meters	24
9.5 Currency	25
9.6 OTM	25
9.7 File Check	26



9.8	Reset	26
10	Operator menu	27
10.1	Accountancy	27
	Main accounting	27
	Main Accounting	27
	Long term accounting	27
	Mechanical Meters	27
	Journal	27
	Hopper	28
	Hopper statistic	28
	Refill Hopper	28
	Hopper Revision	28
	Game statistics	29
10.2	Test mode	29
	Display / Touch	29
	Audio	29
	PC	29
	Coin Acceptor	29
	Note Acceptor	29
	Buttons / Switches / Lamps	29
	Mechanical Meters (if installed)	29
	Hopper	30
10.3	Configuration Settings	30
11	Supervisor Menu	31
11.1	Start Page	31
11.2	Ticket Payout	31
	Scan and Payout	31
	Ticket List	32
11.3	Journal	32
11.4	Audit Info	32
	Long term accounting	32
	Game statistics	32
11.5	Accounting	32
	Supervisor	32
	Attendant 1, 2 and 3	33
	Machine accounting*	33
	Main accounting (Operator)*	33
11.6	Configuration Settings*	33
11.7	Basic Settings	33
12	Attendant 1/2/3 Menu	35
12.1	Start Page	35
12.2	Ticket Payout	35
12.3	Journal	35
12.4	Attendant accounting	35
12.5	Basic Settings	35



13 Demo mode	37
14 Games	39
14.1 Pyramids of Giza	39
14.2 Euro Soccer	39
14.3 Indian Treasure	39
14.4 Caribbean Gold	40
14.5 Royal Liner	40
14.6 Roulette	40
14.7 Royal Poker	40
14.8 Keno	41
14.9 Aloha Hawaii	41
14.10 Hot Fruits	41
14.11 Secrets of Maya	41
14.12 Bingo	42
14.13 Double Bingo	42
14.14 Mystic Ocean	42
15 Protocol IDs	43
16 Error messages	45
17 Comestero RM5/6 Coin Acceptor maintenance	47
18 JCM UBA-10-SS Bill Acceptor maintenance	49
19 MEI Cashflow SC83 Bill Acceptor maintenance	53
20 Astro GBA HR1 Bill Acceptor Maintenance	55
21 Ithaca Epic 950™ ticket printer – paper load and maintenance	59
21.1 Loading Tickets into Feeding Mechanism	59
21.2 Removing Loaded Tickets (paper jam)	60
21.3 Cleaning the Printer Head	60
22 Azkoyen - Hopper Rode U II Plus Maintenance	63
23 Replacing Coin or Bill acceptor	65
24 Declaration of CE conformity	67
25 EULA for Microsoft Software	69
26 Warranty terms by TAB-Austria GmbH & CoKG	73
27 Notes	77



Safety Information

Safety regulations for the user: The machine should only be operated in a dry room and connected to a safety plug socket that complies with the relevant safety standards.

- Before starting the machine, it should be allowed to attain room temperature.
- Check the main voltage before connecting the machine!
- The machine is designed for an alternating voltage of 230 Volts (*or 115 Volts if specified on the type plate*), 50 Hz (*or 60 Hz*) and 190 W / 1,1 A (2,2 A) power.
- The machine may only be operated with two 3,15 amp fuses.
- In case of damage to housing parts, protruding wires, machine fires or smashed picture tubes, the machine must be immediately switched off and the main plug disconnected.
- Defective or bare wire cables, especially power cables and plug connectors must be replaced.

IMPORTANT !

In such cases ensure that any machine contact is avoided and that it cannot be switched on !

- The recommended ambient temperature is between 5 and 35 degrees on the Celsius scale.
- The recommended working temperature is between 15 and 40 Degrees on the Celsius scale.
- The recommended absolute humidity is between 30% and 75% RG, not condensed.
- When positioned alongside other machines, interference in normal operation may occur.



- Fix the socket of the machine on the floor like described in the following picture.

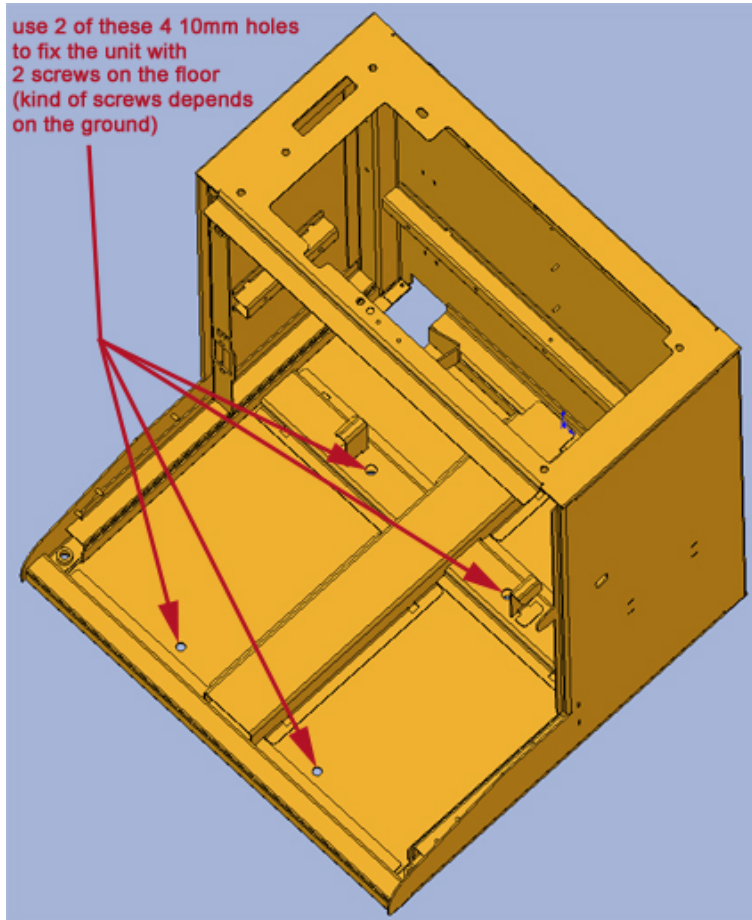

Please pay attention to the licensing terms and conditions of Microsoft (see chapter 25, page 69)





Disposal of Old Electrical and Electronic Equipment (Applicable in the European Union and other European countries with separate collection systems)

This symbol on the product or on its packaging indicates that this product shall not be treated as household waste. Instead it shall be handed over to the applicable collection point for the recycling of electrical and electronic equipment. By ensuring this product is disposed of correctly, you will help prevent potential negative consequences for the environment and human health, which could otherwise be caused by inappropriate waste handling of this product. The recycling of materials will help to conserve natural resources. For more detailed information about recycling of this product, please contact your local city office, your household waste disposal service or the company where you purchased the product.

IMPORTANT:

When you work on the machine, you must turn off the machine and plug out the power. Service on the machine may be done only from qualified personal.

Inside of the machine there is the following sticker. Please show it to the qualified personal before servicing.



Description

2.1 General

The Golden Island Nevada is an ergonomically designed gaming machine. The machine contains normally an electronic coin acceptor, an electronic banknote acceptor, two 19 inches TFT displays with touchscreen on the lower screen and a complete PC system.

2.2 System components

- 19 inch TFT-display with touch screen
- 19 inch TFT-display with safety glass
- Electronic coin acceptor (Comestero RM5 or RM6)

Options

- Banknote reader Astro Systems HR1 (drop box)
- Banknote reader JCM UBA-10-SS (stacker)
- Banknote reader MEI Cashflow SC83 (stacker)
- Switch lock system (USB EKEY-TAB)
- Key switch
- Up to 2 hoppers (Azkoyen Rode U II plus)
- Ticket Printer Ithaca Epic 950TM for 600 tickets

PC System

- PC System with Intel Pentium Core 2 Duo E4300 (2x1,8 GHz) or E4600 (2x2,4 GHz) or higher
- PCIe-graphics card 46xx-series with ATI™ chip (1280 x 1024 resolution)
- On-Board 16 bit soundcard
- Mimimum 80 GB SATA hard disk drive
- TAB I/O controller with secure memory



2.3 Operating Elements

All games in the Golden Island Nevada are played via touch screen and/or push buttons. There are 8 push buttons in total that can be used optionally to the touch screen for various functions.

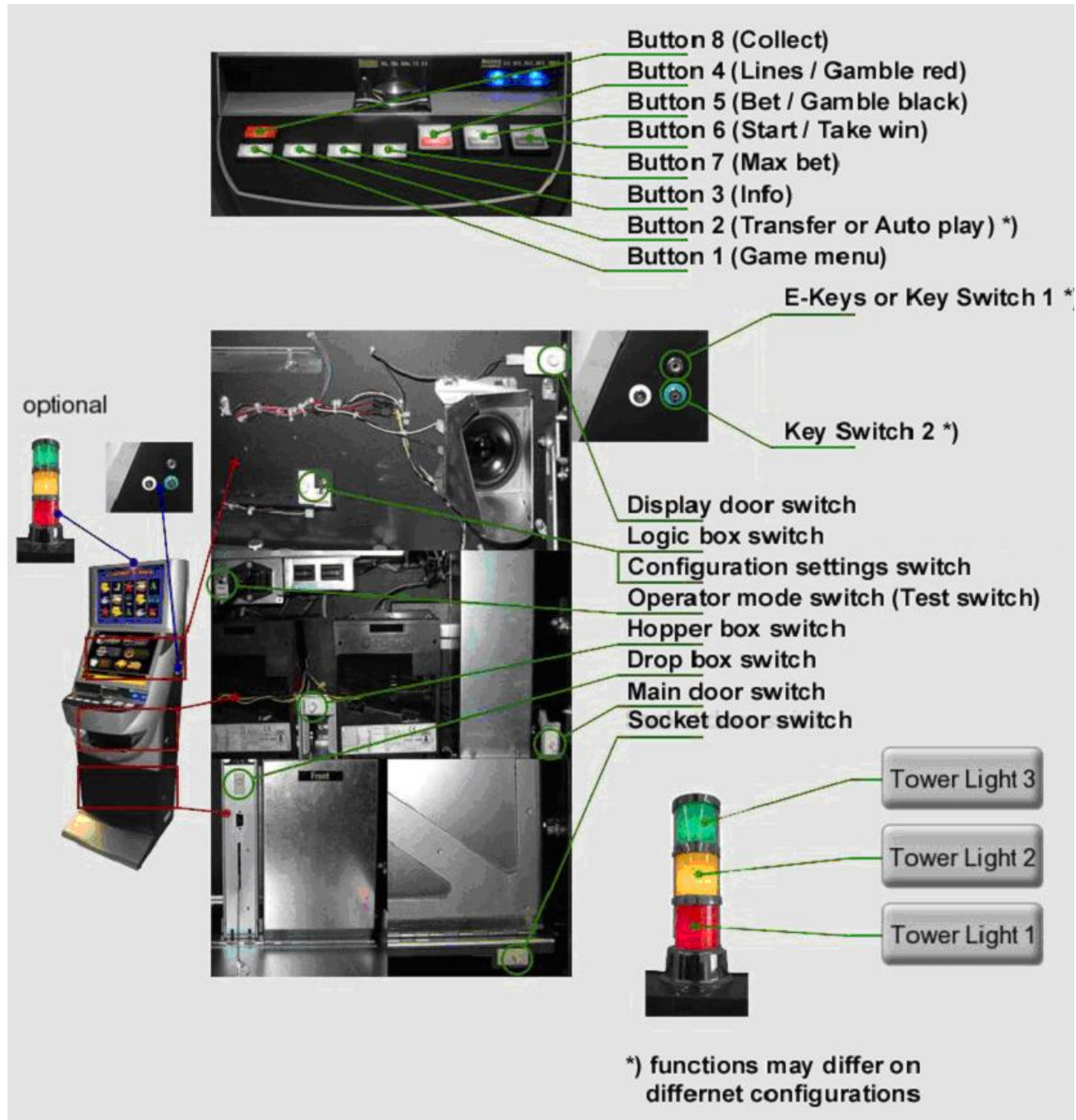

Technical Data

3.1 Machine dimensions

	Unpacked	Packed
Depth	54 cm	59 cm
Width	52 cm	77 cm
Height	175 cm	182 cm
Weight ¹	122 kg	133 kg

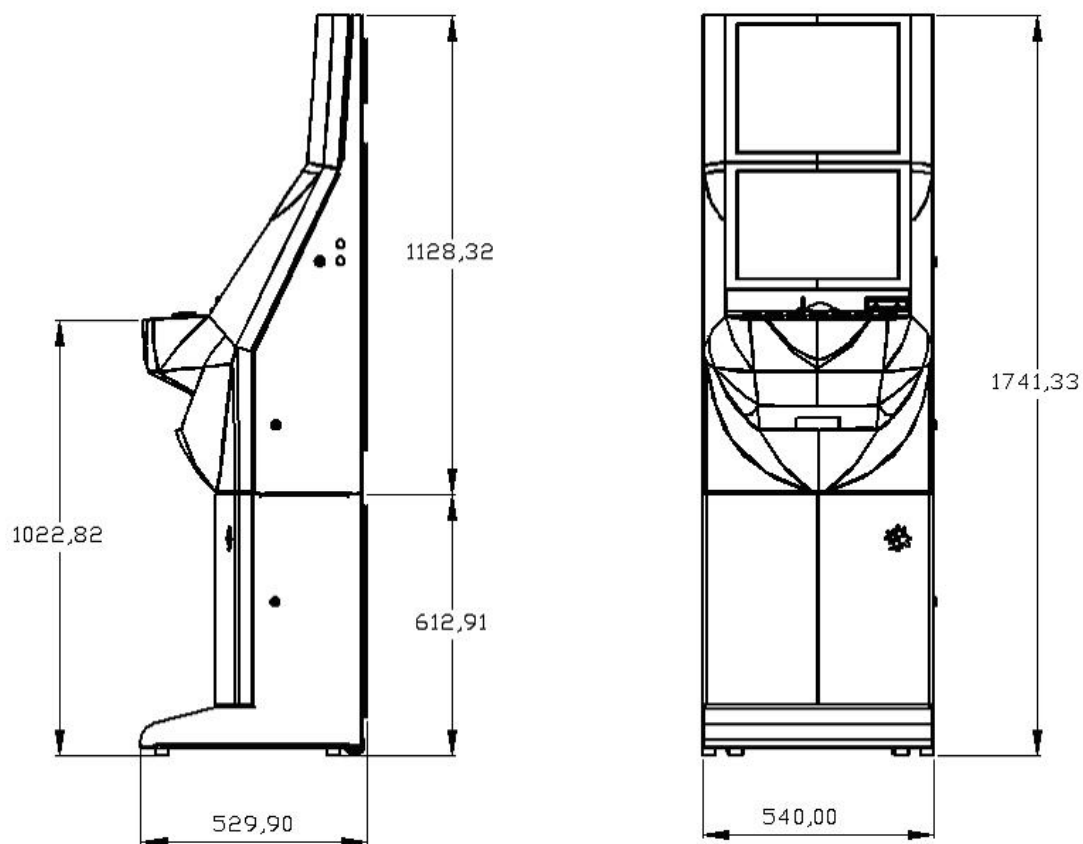

3.2 Electrical Data

Electricity: 230 V AC 50 - 60 Hz
 Performance: 190 watts
 Cutout: 2 x 3,15 amperes

Note:

When you have more than one machine on a voltage splitter please note: With a normal installed electricity port with a cutout from 16 ampere do not plug in more than 3 machines.

¹The weight may vary depending on the installed optional components



Initial Operation

Each machine has already been tested at the factory and is delivered with initial settings pre-programmed.

We recommend a 15 minutes warm up time before initial operation so that the machine can reach optimal operation temperature.

However, temperature differences can change the touch screen settings so that they are no longer correct. Therefore, when a machine is put in operation for the first time, we recommend performing a Touch screen calibration

1. Connect the power cord
Open the Main door
Insert the power cord from the back into the machine and plug it into the socket on the rocker switch
2. Turn on the machine:
Turn on the rocker switch
The machine will boot and the program starts automatically
3. Touch screen calibration:
 - a) enter the Operator menu by turning on the operator switch
 - select Test mode and press button perform touch calibration
 - sit in a perfectly straight way, well-centered position, at a 90° angle in front of the machine and follow the instructions on the display exactlyor
 - b) enter the Supervisor or Attendant 1/2/3 menu by inserting the corresponding EKEY
 - select menu Basic Settings
 - press button perform touch calibration
 - sit in a perfectly straight way, well-centered position, at a 90° angle in front of the machine and follow the instructions on the display exactly
4. Setting the volume:
 - a) enter the Operator menu by turning on the operator switch - adjust the volume on the top page by using the slider
or
 - b) enter the Supervisor or Attendant 1/2/3 menu by inserting the corresponding EKEY
 - select menu Basic Settings
 - adjust the volume by using the slider



5. If you set up the machine for the first time, please proceed with the following steps:
- a) enter the Configuration settings menu (see chapter 9, page 19)
 - b) perform either a
 - RAM clear (all accounting data, statistic data and event logs will be cleared)
or a
 - Factory reset (all configuration settings will be reset to their default values and all accounting data, statistic data and event logs will be cleared)(see chapter 9.8, page 26)
 - c) check and set all Configuration settings



Boot Up menu by activated test switch

By switching on the test switch (also called operator switch, located by the rocker switch) before booting the machine you are able to enter the following programs (only during normal start):

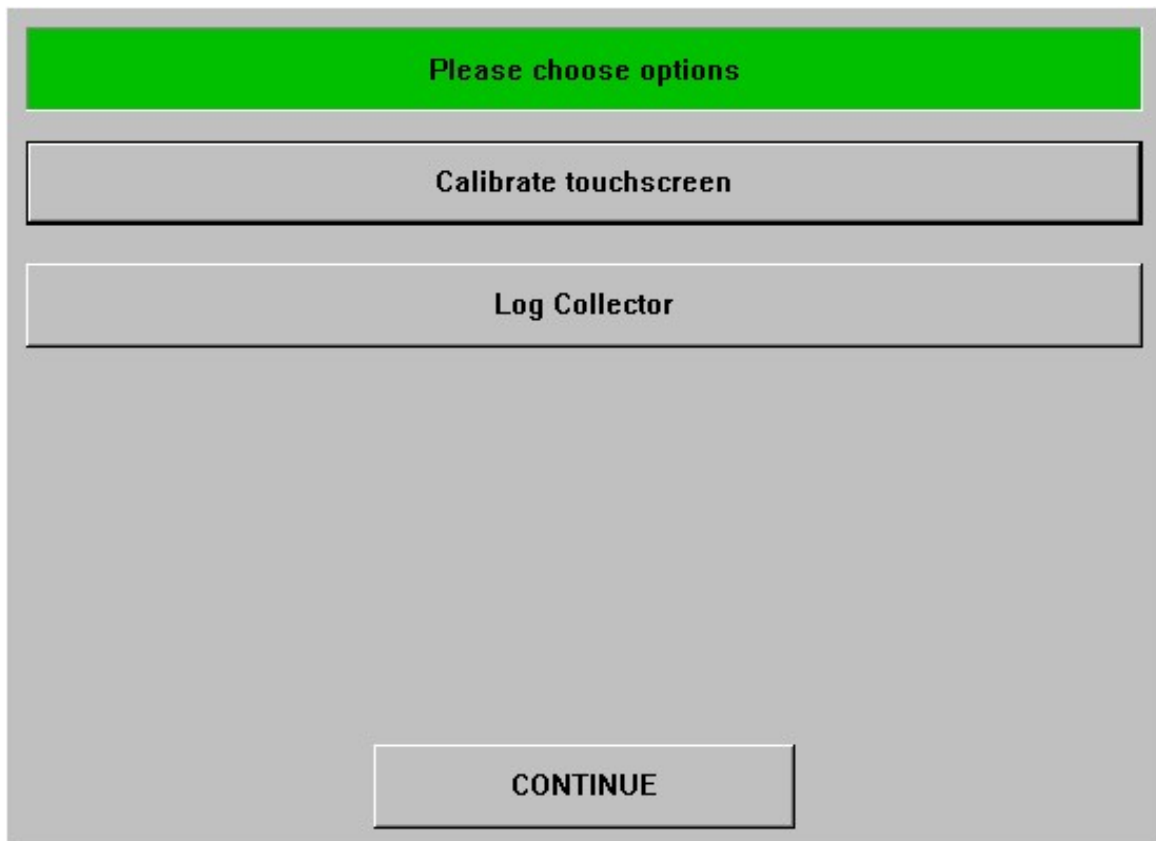

You can select the different buttons by pressing the hardware buttons on the panel of the machine

- Calibrate touch screen
4 point calibration of the touch screen will be performed
- Log Collector
transfers warning and error logs from the machine to a connected USB stick. As the transfer folder on the USB stick contains the machine number, the stick can be used to collect data from multiple machines





This dialog prompts you to insert or remove an USB stick at the PC



Update process

Note: For some configurations the PC box is sealed or there is no Update connector on the PC box because it is not allowed to perform an Update.

During the Update process the PC box must be connected to the cable harness because the initialisation process will determine the type of machine by cable detection and perform the right initialisation.

If you get a new Update from TAB with new games or you have to update the machine because of a defect hard disk drive please perform the following:

- Switch off the PC (switch on the power supply) or the whole machine
- Turn down the PC box so you have access to the Update disk connector located outside on the top of the PC
- Insert the Update disk into the connector
- Switch on the PC
- The Update process will start automatically. It is finished when you see the message: „UPDATE FINISHED - Please switch off, remove Update disk and switch on again“.

Please perform in that way.

- After switching on again the installation process will perform until the message „please calibrate touch screen“ will appear.
- Please perform the 4 point touch screen calibration in any way because some initial data will be stored on the hard disc.

After the initialisation process the „enhanced write filter“ will be activated and it is no longer possible to perform this initial touch screen calibration.

- The machine will boot up into normal game mode or
- The message „Secure Memory Error!“ will appear if you have changed the dongle or installed a new version of Golden Island Software.

In this case please perform a Factory reset (see chapter 9.8, page 26) and proceed with the Configuration settings menu (see chapter 9, page 19)

- Factory Reset: Enter the Configuration settings menu by turning on the Configuration settings switch which is located inside the Logic box

On the screen press the button „Perform Factory reset“

All configuration settings will be reset to their default values and all accounting data, statistic data and event logs will be cleared! The machine will boot up once more and afterwards you can setup the configuration setting:



- Please check at least these configuration settings:
 - Time / Date
 - select your time zone first and if you like automatically daylight saving changes (strictly recommended).
 - Correct the actual time and date if necessary (can be changed only after RAM Clear or Factory Reset)
 - Note: if you are using OTM you only have to select the correct time zone. The date and time will be synchronized with the server during the first data transmission.
 - Machine ID
 - Enter the minimum data of the site and the machine :
 - Location Name of Casino / Arcade / Pub
 - Function Assignment
 - Define the assignment of the different functions to the keys
 - Hopper
 - If one or two hopper are connected, please check for the correct hopper coins
 - Ticket printer
 - Please enter the following fields:
 - Validity (30 - 60 days)
 - Banner Text
 - Validation Text
 - Mechanical Meters
 - Set the start value of the mechanical meters.
 - Currency
 - OTM

For a detailed description of these settings please see: „Configuration settings menu“, chapter 9, page 19



Info Page

By pressing the INFO button in normal game mode (or by touching the INFO button on the upper right corner on the touch screen) for a minimum of 3 seconds the following screen will appear:



On this Screen you can see:

- Actual date and time
- MD5 checksum of the program
- Configuration and Dongle version number
- Software version and System version
- Machine serial number
- Machine ID (if set in configuration settings)
- OTM number (if registered on OTM server)



Service Menu - different levels

There are different security levels:

- Configuration settings menu
Initial set up and configuration by the operator
(see chapter 9, page 19)
- Operator menu
Accountancy (Main accounting, Journal, Game statistics), Test mode, non-critical Configuration settings (language, hopper limits)
(see chapter 10, page 27)
- Supervisor menu
Hand Deposit, Hand Pay, Ticket Pay, Journal, Volume, Touch calibration, Supervisor and Attendant accountancy, Main Accountancy*, Configuration settings*
* if allowed (see Configuration settings: Security, chapter 9.1, 20)
(see chapter 11, page 31)
- Attendant 1 / 2 / 3 menu
Hand Deposit, Hand Pay, Ticket Pay, Attendant accountancy, Volume, Touch calibration
(see chapter 12, page 35)



Configuration settings menu

All of the configuration settings can only be modified if credits are empty.
Some of these settings can be changed only after RAM clear or Factory reset.

Enter the Configuration settings menu by turning on the Configuration settings switch which is located inside the Logic box:

- open the Main door
- open the Display door
- open the Logic box
- turn on the Configuration settings switch

Note:

this manual describes all possible settings of the International version.
Some of these settings may not exist in your configuration.

9.1 Basic Settings

Languages

Select the languages which should be enabled and the basic language.
The machine will switch to the basic language when:

- Credits are zero

and

- No interaction for one minute

Date / Time

Select your time zone ¹ first and if you like automatically daylight saving changes (strictly recommended).

Correct the actual time and date if necessary (can be changed only after RAM Clear or Factory Reset)

Note: if you are using OTM you only have to select the correct time zone ¹. The date and time will be synchronized with the server during the first data transmission.

1. only possible for specific countries



Security

Select the warning messages which you would like to have. In some configurations you cannot change or see several settings, because they are required or not allowed, in case of the jurisdiction of the country.

- „Show Warning after reboot (Clear Warning to continue)“
if enabled, a warning message will be show after power up which must be cleared by the attendant
- „Show Error after opening a door (Clear Error to continue)“
if enabled, a red screen with an error message will appear which must be cleared by the attendant
- „Sound an alarm when door is opened“
if enabled, an alarm sound will be played 3 times
- „Loop alarm sound“
if enabled the alarm sound will be looped continuously until the attendant cleared the error
- „Allow supervisor access to basic configuration settings“
if enabled, the supervisor will have the possibility of changing the following configuration settings from his supervisor menu:
 1. Enable/disable second language if present and selection of basic language (see chapter 9.1, page 19)
 2. changing the hopper limits (see chapter 9.2, page 21)
- „Allow supervisor examination to main accountancy“
if enabled, the supervisor is able to see the main accounting (see chapter 10.1, page 27)
- „Seperate machine accounting for supervisor“
if enabled, there is an seperate accounting for the supervisor which can be deleted by the supervisor. This accounting is independently of the operators main accounting.
- „Check of legal age by attendant required“
if enabled the legal age of a player has to by checked by the attendant. Therefore, the machine is locked after credits have been inserted. The attendant has to unlock the machine by clearing the warning message. If the credit drops to zero during playing the player has 40 seconds time to insert more credits without a new check of the legal age.

Machine ID

Enter the data of the site and the machine:

- | | |
|--------------------------------------|---|
| - Location ^{1 2} | Name of Casino / Arcade / Pub |
| - Machine ID ¹ | Number of the machine in the location |
| - Machine Serial Number ³ | Number of type plate (i.e. GE0012345) |
| - Street/number ¹ | Address of location (i.e. Haiderstr. 40) |
| - Zip code/city ¹ | Address of location (i.e. 4052 Ansfelden) |
| - Phone number | Address of location (i.e. +43 7229 78040) |



- | | |
|-------------------------------------|---|
| - Fax number | Address of location (i.e. +43 7229 78660) |
| - Email address | Address of location (i.e. sales@tab.at) |
| - Dongle Serial Number ³ | Number of the configuration Dongle device |
| - Machine data ³ | Several data's of machine like part number or configuration |

Note: after OTM-registration, these datas can only be modified on the OTM server.

1. data's marked with ¹ will be printed on the ticket, if a printer is installed (see chapter 9.4, page 23)
2. data's marked with ² must be entered for OTM registration
3. Non-editable field. Data is set automatically from a Dongle device

9.2 Game + Limit Settings

Games

- Enable/disable games
- Enable/disable secondary games (i.e. Gamble)
- Changing of payout percentage (only if possible in current configuration)

Limits

This menu/settings are only visible in certain configurations.

- Selection of Minimum and Maximum Bet
- Selection of Gamble Limit and the maximum number of Gamble up
If the winnings are higher than half the Gamble limit, the Amount will be collected automatically.
If the gamble limit would be reached by winning the next stage of the Gamble game, the machine finishes the Gamble automatically and collects the Win.

Hopper Limits

This section is only visible and available if minimum one hopper is activated.

- Direct Pay To
If the credit is higher than this level and the player presses „Hopper Payout“ the message „Hopper payout limit. Please call Attendant“ will be shown.
If a „Direct Pay To“ Limit is set and on Players Payout request are not enough coins in the hoppers the message „Hopper low: Hand Pay required“ will be shown.
The Attendant must perform Hand Pay of the whole amount.



- Lockout Level

If hopper level is below this level, banknote acceptor will be disabled (locked) and the text „coins only“ will be shown on the display bar of the game

- Hopper Float Level If hopper level is below this level, the text „insufficient coins (<value of hopper coin>)“ will be shown
- Hopper Divert Level Maximum number of coins allowed in the hopper. If hopper level is above this level, all coins are diverted into the drop box

9.3 Function Assignment

Here you can see the assignment of the different functions to the keys
How to change an assignment:

- Press the corresponding „Change“ button, the message „Press switch or insert E-Key“ will appear
- Press the switch of insert the E-Key you would like to map for this function.
 - if you press/turn a key, confirm with „OK“
 - if you insert a E-Key you can select the colour of the key and label it with i.e. the name of the Attendant, then confirm with „OK“

The configuration settings switch cannot be relocated.
Each function assignment can be cleared by pressing the corresponding „Clear“ button.

9.4 Hardware Settings

Coin acceptor

Here you can enable / disable the different coin channels

Note acceptor

Here you can enable / disable the different note channels
Enter the „cctalk encryption key“ if required by the Note acceptor

Remote / Collect

This menu is only visible in certain configurations. Additional settings may appear or are not available.

- Hand Deposit
if enabled, Hand Deposit (from the supervisor or attendants menu) is allowed
- Hand Pay
if enabled, Hand Pay (from the supervisor or attendants menu or with the corresponding key switch / E-Key which is assigned to that function (see chapter 9.3, page 22)) is allowed



- Collect Button active -> Call Attendant Message
if enabled, the collect button is active. If a player presses the collect button, the message „Hand Pay required, please call Attendant“ will appear on the screen and the machine is locked

Hopper

If one or two hopper are connected, you can activate them by selecting the box „activate“
Once a hopper is activated, you can select the value of the hopper coins
(These settings can be changed only after RAM Clear or Factory Reset)

The gaming machine will pay the minimum number of coins
(as many as possible with the higher coin, the rest with the lower coin)

If the hopper content is less than the whole amount, the following message will be shown:
„Insufficient coins for Payout. Please call Attendant“

You can change the payout strategy by enabling or disabling the checkbox „If Hopper 2 is running empty, payout of remaining amount with Hopper 1“

Ticket Printer

This menu is only visible in certain configurations.

If a ticket printer is connected, you can activate it by selecting the box „activate“

ATTENTION: for ticket printing the machine must be registered to the OTM server and must have a stable internet connection!

- Validity (30 - 60 days)
select the number of days the ticket is valid
- Banner Text
select the text printed above the bar code
- Validation Text
select the „validation“ text
- Advertising Text
select the text you want to be printed in the advertising field

Examples of Cashout Tickets (depending on the configuration there are two different layouts possible):

- Location *	Name of establishment
- Street/number *	Street / Number
- Zip code/city *	Zip code / City
- Banner Text	CASHOUT TICKET
- Validation Text	VALIDATION
- Next Voucher number	1
- Validity	30



The machine also counts the right number in case of power loss.
Therefore the basic value of the currency (i.e. 1 Euro) is recommended for this setting.
(These settings can be changed only after RAM Clear or Factory Reset)

9.5 Currency

On some configurations you are able to select the Currency.

On some configurations it is also possible to change all game displays to credits instead of the currency.

If Credits are selected, you can change the value for one credit.

(These settings can be changed only after RAM Clear or Factory Reset)

9.6 OTM

This menu is only visible in certain configurations.

If so, the machine can be connected to the OTM System of TAB-Austria.

If connected, the machine will transmit several data's to the OTM-Server of TAB-Austria.

The operator can check the accountings „Total In“ and „Total Out“ on a secure TAB webpage (<https://service.championsnet.net>) and therefore he is able to supervise all his machines which are connected to the system.

OTM number:

This is a number which will be assigned from the server to this machine during the registration process.

If there will occur a problem, this number is important for the Hotline of TAB.

Location number:

This is a number which will be assigned from the server to the location of this machine during the registration process.

Button „Check connection“:

Here you basically can check the connectivity to the internet.

Registration for Live systems:

Press one of the Registration Buttons to register the machine either for a new location or an existing location. For a new location you can fill out all location specific data on the machine or update this information on the website. To register a machine for an existing location just provide the location name or the location number.

TAN-Code:

For registering a machine to the system, please enter a valid TAN-Code from your OTM account and press button „Register“.

The machine has to be connected with a CAT-5 network cable to a router which is configured for DHCP (obtain an IP address automatically)

ATTENTION:



for security reasons DO NOT connect the machine to the internet directly without a router with NAT (network address translation)!

If you are running a network with integrated firewall please make sure that the following port is open:

TCP 443 outgoing

Connection (expert mode):

These settings you only need in special environments (like company networks) where you have to configure a proxy server. In this case, please ask the network administrator for the data's.

If you don't have such a special environment please make sure that the check box 'use DHCP' is selected!

9.7 File Check

If one or more files are corrupt, they will be displayed on this page.
(if the machine is still working)

9.8 Reset

- Perform RAM clear
All accounting data, statistic data and event logs will be cleared!
- Perform Factory reset
All configuration settings will be reset to their default values and all accounting data, statistic data and event logs will be cleared!



Operator menu

Enter the operator menu by activating the switch or E-Key which is assigned to this function (see chapter 9.3, page 22).

The default mapping is the operating switch inside of the machine behind the main door labelled with „TEST“ beside the rocker switch.

On the start page you can adjust the volume and activate „Demo mode“ For „Demo mode“ please see chapter 13, page 37

10.1 Accountancy

Main accounting

Main Accounting

This page is the main accounting page for the operator.

You will see a summary of all Cash In and Cash Out devices and the Total Result.

In the box „Accounting with Supervisor“ you will see the Total amount of money the supervisor has to give to you (the operator) (colour green) or will get from you (colour red).

On the right you see the power up and door opening meters

This Accounting you may normally clear after each collecting of cash box.

Long term accounting

A separate accounting page of the most important meters.

It depends on the Configuration if this page can be cleared or not.

Mechanical Meters

A electronically copy of the mechanical meters

If the start value was set correctly (please see chapter 9.4, page 24) this value must correspond to the mechanical meters.

Maybe it can differ if the machine has been switched off frequently while the mechanical meters are counting.

Journal

Some sections may not be visible in certain configurations.

Here you can see the following data's:

- Last 10 Game data (visualized)
- Latest data (last 10 coins, last 10 Banknotes, last 10 Game data)
- Last 1000 games



- Last Tickets printed
- Machine journal (all changes of settings, door openings, actions of Supervisor and attendants, ...)
- Error log (if the machine is running fine, you should not see any errors on this page)

Hopper

Hopper statistic

Here you can see a detailed list of all hopper accountings:

- Hopper IN: Coins went into hopper through coin acceptor during normal play
- Coin acceptor refill: Amount of coins inserted through coin acceptor from Operator, Supervisor or Attendant during Hopper refill mode
- Manual Refill: Amount of coins which are refilled manually by the operator (the operator has to enter the amount manually, please see chapter 10.1, page 28)
- Hopper OUT: Coins which were paid out from hopper
- Too many Coins: the bookkeeping system detected a higher amount of coins in the hopper than expected
- Missing coins: Amount of missing coins. If the hopper runs out of coins during payout but there should be already some coins in the hopper.
- Unexpected Payout: Coins from a unattended pay out
- Manipulated payout: coins which are paid out in case of manipulation
- Hopper Revision: Amount of coins which are corrected manually during the hopper revision (please see chapter 10.1, page 28)
- Hopper content: Virtual amount of coins (cash) in the hopper

The statistics will be resetted by clearing the main accounting.

Refill Hopper

On this page you can refill the hopper either with insertion of coins through the coin acceptor or by filling the coins into the hopper directly - but then you have to enter the amount of the refilled coins manually.

Hopper Revision

Here you can count the content (number of coins) of the hopper and adjust or correct it to the correct hopper level.

The coins will be paid out but will not be booked on any accounting.

You have to return them into the hopper.

If the amount differs please correct it by entering the correct number of coins.



Game statistics

Detailed list of Number of games, Bet, Win and Win percentage of primary games and secondary games.

The operator is able to clear this statistics at any time.

10.2 Test mode

The Test mode gives you the possibility to test the whole machine without an influence of the accounting.

Display / Touch

Show test image - to adjust the display

Verify touch calibration

Perform touch calibration - 4 point touch calibration

Audio

Test the left and right speaker

PC

Detailed list of all parts of the PC For inspection please check:

- CPU temperature (should be not higher than 70°C)
- CPU Fan (should not be zero!)
- Hard disk temperature (should be not higher than 60°C)

Coin Acceptor

Test the different coin channels

Note Acceptor

Test the different bank note channels

Buttons / Switches / Lamps

Test all buttons, switches and lamps.

If you press on of the game buttons the corresponding lamp will lit.

Mechanical Meters (if installed)

You can see if the meters are connected and if there are some outstanding ticks.

It is not possible to test the meters because by a test the figure of the meters would not be correct anymore.



Hopper

Here you can test the hopper by paying out one coin or all coins.
If you leave this menu, the payout will be stopped.
No payout will be counted in this mode.

10.3 Configuration Settings

Depending on the configuration, it is possible to change some configuration settings like the basic language or hopper limits.



Supervisor Menu

Enter the supervisor menu by activating the switch or E-Key which is assigned to this function (see chapter 9.3, page 22).

The default mapping is the supervisor key switch on the right side outside of the machine. Depending on configuration, some menus may not be available.

11.1 Start Page

This is the most important page for the supervisor. His attendants have the same Start page but counting on their own accountancy.

- Credits: in the first field the actual value of credit is displayed
- Hand Deposit: Possibility to add Credits.
It will be counted to the Supervisors „Hand Deposit“
- Hand Pay: Possibility to reset Credits.
It will be counted to the Supervisors „Hand Pay“
- Hopper Refill: Possibility to refill both Hopper.
It will be counted to the Supervisors „Hopper Refill“
(only available when Hopper are activated)

Note: Some fields are not available on several configurations.

11.2 Ticket Payout

This menu is only visible in some configurations. OTM registration is required!

Scan and Payout

This page is used to pay out tickets. The ticket can be inserted into the banknote reader or the validation code can be entered manually.

After a valid ticket was inserted the ticket information will be shown. The ticket information include all essential information to pay out the ticket:

- Amount
- Validation code
- Date and Time
- Ticket number
- Location
- Machine ID



If the ticket can not be payed out the reason will be show:

- Ticket is invalid - If the ticket was inserted it might have been read incorrectly. If the code was entered manually it might have been mistyped.
- Ticket is expired
- Ticket is from another location
- Ticket is already paid

Ticket List

On this page the tickets on the server can be viewed. All tickets of the selected time period and all unpaid tickets will be shown. Unpaid tickets will be shown in red, paid tickets will be shown in green and expired tickets will be shown in blue.

11.3 Journal

Please see chapter 10.1, page 27

11.4 Audit Info

This menu is only visible in the configuration ZA.

Long term accounting

A separate accounting page of the most important meters.

Game statistics

Detailed list of Number of games, Bet, Win before and after Gamble of primary games and secondary games.

11.5 Accounting

Supervisor

This is the main accounting page for the Supervisor.

In the first field the accountings of the Supervisor are displayed. The supervisor can delete these accountings at any time.

This will not affect the accountancy on the Operator's main accounting page where the Operator makes the settlement with the Supervisor.

In the second field there is the statement of all 3 Attendant accountings



In the third field there is the summary of the accountings of Supervisor and Attendant 1, 2 and 3 and the total sum which the Supervisor has to give to the Operator (in colour red) or which he will get from the Operator (in colour green).

Attendant 1, 2 and 3

The Supervisor is responsible for the settlement with the Attendants 1, 2 and 3. For that procedure, there are 3 additional Tabs for the 3 Attendants which are showing the responsible accountings and the total sum which the Supervisor will get from the Attendant (in colour green) or he has to give to the Attendant (in colour red).

To clear an Attendants' accounting, insert the corresponding E-Key of the Attendant, then press button „Clear“. (After removing the Attendant's E-Key please reinsert the Supervisor's E-Key again, otherwise the Supervisor Menu will be left when switching to another menu)

Machine accounting*

This page shows the accounting of the machine which can be deleted by the supervisor. This accounting is independently of the operators accounting.

* This page is only visible for the Supervisor if the checkbox „Seperate machine accounting for supervisor“ is enabled in the Configuration settings - Security. (see chapter 9.1, page 20)

Main accounting (Operator)*

This page is the main accounting page of the operator. The Supervisor is only able to see this accounting, he cannot delete it.

* This page is only visible for the Supervisor if the checkbox „Allow supervisor examination to main accountancy“ is enabled in the Configuration settings - Security. (see chapter 9.1, page 20)

11.6 Configuration Settings*

Depending on the configuration here it is possible to change some configuration setting like the basic language or hopper limits

* This page is only visible for the Supervisor if the checkbox „Allow supervisor access to basic configuration settings“ is enabled in the Configuration settings - Security. (see chapter 9.1, page 20)

11.7 Basic Settings

Here you can adjust the volume, check and calibrate the Touch screen.



Attendant 1/2/3 Menu

Enter the attendant menu by activating the switch or E-Key which is assigned to this function (see chapter 9.3, page 22).

There is no default mapping.

12.1 Start Page

Please see chapter 11.1, page 31

12.2 Ticket Payout

Please see chapter 11.2, page 31

12.3 Journal

Please see chapter 10.1, page 27

12.4 Attendant accounting

This is the main accounting page for the Attendant.

This accounting only can be cleared from the Supervisor Menu - Attendant accounting - on the corresponding Attendant Tab.

Please see chapter 11.5, page 32

12.5 Basic Settings

Please see chapter 11.7, page 33



Demo mode

Only available in certain configurations

The operator can set the machine into Demo mode on his start page.

If Demo mode is activated, you can test and play with the machine but no events will be recorded or accounted.

If credit will come to zero, credit will be increased automatically.

By pressing and holding the Collect button while pressing start on most of the Reel games will trigger the feature game combination.

Holding the Collect button by pressing start during the feature games, the sequence will be aborted.

On Royal Poker the combination for Ace bonus will be triggered.



Games

The availability of games may depend on configuration.

14.1 Pyramids of Giza

10-line, 5-reel game

All wins pay left to right

SPHINX substitutes for all symbols except PYRAMIDS

Feature Game

PYRAMID on reel 1, 3 and 5 awards 10 Feature Games

During Feature Games also PYRAMID substitutes for all symbols.

Feature Games can be won again during the feature and are played at current bet.

14.2 Euro Soccer

10-line, 5-reel game

All wins pay left to right

BALL substitutes for all symbols except GOAL

Feature Game

3, 4 or 5 scattered GOAL awards 15 Feature Games

During Feature Games all wins pay double.

Feature Games can be won again during the feature and are played at current bet.

14.3 Indian Treasure

10-line, 5-reel game

All wins pay left to right

Pocahontas substitutes for all symbols except Treasure.

Feature Game

3, 4 or 5 scattered Treasure awards 15 Feature Games

During Feature Games all wins pay triple.

Feature Games can be won again during the feature and are played at current bet.



14.4 Caribbean Gold

5-line, 5-reel game
All wins pay left to right

14.5 Royal Liner

5-line, 9-reel game
All wins pay left to right

14.6 Roulette

Roulette with 36 numbers and Zero.
Players may place their chips on the following positions:

- „Red“ - „Black“
- „Even“ - „Odd“
- „1-18“ - „19-36“
- „First dozen“ - „Second dozen“ - „Third dozen“
- „Colonne“... on the columns 1-34, 2-35 or 3-36
- „Six line“... on six consecutive numbers consisting of two consecutive cross rows (e.g. 4-5-6-7-8-9)
- „Corner“... on four numbers that create a square on the table (e.g. 1-2-4-5)
- „Street“... on three consecutive numbers consisting of one cross row on the table (e.g. 1-2-3 but also 0-1-2 or 0-2-3)
- „Split“... on two numbers that are either vertical or horizontal neighbours (e.g. 15/18 or 28/29)
- „Full Number“... on one of the 37 numbers

14.7 Royal Poker

The game is played with 52 cards plus one Joker.

Rules of the game:

The „1st Deal“ is started with the „Start“ button and your bet is deducted from your credit.

Five consecutive cards will be dealt face up. If „AutoHold“ is selected, a hold suggestion will be displayed for the best possible winnings.

This hold suggestion may be changed by pressing the cards.



The „2nd Deal“ is started with the „Start“ button with no deduction from your credit.
All cards which are not held will be changed.

14.8 Keno

The computer will draw 20 numbers from a total of 80 at random.
Select between two and ten numbers by pressing the desired numbers.
The selected number fields will be displayed in *yellow*.
Pressing a number a second time deselects it.
All possible prizes are shown in the prize table.
The values in the prize table change depending on the number of selected numbers.
The game is started with the *Start* button.
Twenty numbers will be drawn.
If a drawn number corresponds to a selected number (hit), this number field will be shown in *green*, otherwise it will be shown in *red*.

14.9 Aloha Hawaii

10-line, 5-reel game
All wins pay left to right
Hula Girl substitutes for all symbols except Surfer.
Hula Girl doubles win when substituting

Feature Game

3, 4 or 5 scattered Surfer award 15 Feature Games
During Feature Games all wins pay double.
Feature Games can be won again during the feature and are played at current bet.

14.10 Hot Fruits

10-line, 5 reel game
All wins pay left to right except Scatters

14.11 Secrets of Maya

10-line (5-line in configuration ZA), 5 reel game
All wins pay left to right except Scatters
Pyramid substitutes for all symbols except Calendar

Feature Game

3, 4 or 5 scattered Calendars award 10 Feature Games
During Feature Games Pyramids on Reel 1, 3 and 5 substitute for the whole reel.
Feature Games can be won again during the feature and are played at current bet.



14.12 Bingo

Bingo game with 3-8 tips

Game rules:

Highest win only paid.

Between three and eight numbers can be selected.

20 numbers from a total of 80 are drawn.

If „Extra Balls“ are won the player has the possibility to buy two more balls for the same bet.

The values in the prize table change depending on the number of selected numbers.

14.13 Double Bingo

Bingo game with 3-8 tips

Game rules:

Highest win only paid.

Between three and eight numbers can be selected.

20 numbers from a total of 81 are drawn.

The ball „x2“ doubles the win.

If „Extra Balls“ are won the player has the possibility to buy two more balls for the same bet. The values in the prize table change depending on the number of selected numbers.

14.14 Mystic Ocean

10-line, 5-reel game

All wins pay left to right

Mermaid substitutes for all symbols except Dolphin.

Mermaid doubles win when substituting

Feature Game

3, 4 or 5 scattered Dolphin award 15 Feature Games

During Feature Games all wins pay triple.

Feature Games can be won again during the feature and are played at current bet.



Protocol IDs

GameID	Game name
1	Roulette
2	Keno
3	Royal Poker
4	Caribbean Gold
5	Royal Liner
6	Pyramids of Giza
7	Euro Soccer
8	Indian Treasure
9	Aloha Hawaii
10	Hot Fruits
11	Mystic Ocean
12	Secrets of Maya
13	Bingo
14	Double Bingo
50000	MenuPayoutGame (configuration ZA only)



Error messages

Message	Reason	Could be caused by
Meter IN disconnected Meter OUT disconnected	The declared meter is not connected to the IO controller card on the PC box	Broken wire Meter defect IO controller defect
Hopper 1 disconnected Hopper 2 disconnected	The declared hopper is not correct connected to the IO controller card on the PC box.	Hopper was not connected at starting the GI software (restart the machine) Hopper is not connected Broken wire Hopper defect IO controller defect
Jam Hopper 1 Jam Hopper 2	The declared hopper is jammed	Hopper is jammed (remove jammed coins) Broken wire Hopper defect IO controller defect
Fraud suspected Hopper 1 Fraud suspected Hopper 2	Coins leaved the hopper without starting the hopper from the software	Coins leaved the hopper because of vibrations Broken wire Hopper defect IO controller defect Hopper is started with external voltage (fraud) Test the hopper in service mode and normal game mode
Hopper 1 disabled Hopper 2 disabled	The declared hopper is disabled (e.g. of fraud suspected message)	
Hopper 1 locked Hopper 2 locked	The declared hopper is locked	
Hopper error! Hopper 1 Hopper error! Hopper 2	Common malfunction of the declared hopper For hopper errors without a specified message	Broken wire Broken connectors Hopper defect IO controller defect Test the hopper in service mode and normal game mode



<p>Coin acceptor disconnected Note acceptor disconnected</p>	<p>The declared cash acceptor is not connected correctly to the IO controller on the PC box.</p>	<p>Cash acceptor disconnected Another cash acceptor is connected an runtime Broken wire Cash acceptor defect IO controller defect Test the declared cash acceptor in service mode and normal game mode.</p>
<p>Dongle not accepted!</p>	<p>Wrong dongle connected</p>	<p>Dongle was changed since the last boot up of the machine. Perform a factory reset</p>



Comestero RM5/6 Coin Acceptor maintenance

This fact sheet provides the necessary information for the clearing and maintenance of the RM5/6 electronic coin validator.

Cleaning at regular intervals assures a high quality standard of coin recognition and, in the long run, reduces the risk of error and failure.

External cleaning

The external surfaces of the coin validator are made of a plastic shockproof material (ABS). To clean them it is recommended to use a soft cloth with a neutral detergent. For more resistant dirt ethyl alcohol can be used. To remove excess dust from the coin slots and other narrow spaces the use of compressed air or a paintbrush is recommended.



ATTENTION!

Do not use sharp or abrasive tools, which could damage the surface and the recognizing sensors.

Do not put the coin validator in water or any other type of liquid.

Internal cleaning

In the RM5/6 electronic coin validator the coin recognizing sensors are installed behind a small spring door. Open the door to have access to this space as shown (fig.1).

Clean the excess dirt from behind the door with a grease removing spray, for example a normal detergent for windows and mirrors, removing more resistant dirt with a small brush. Ethyl alcohol can be used.

There are three small holes behind the door. These holes are where the coin recognizing sensors are put in place (fig.2). If dust or dirt blocks these holes the performance of the coin validator could be reduced and, in extreme cases, no coins would be recognized.

To keep the sensors clean whilst in position use compressed air only.



ATTENTION!

Do not use any type of sharp object, such as pins or screwdrivers, to remove dust from the sensors as they could be irreparably damaged putting the coin validator out of use.





(a) Fig. 1

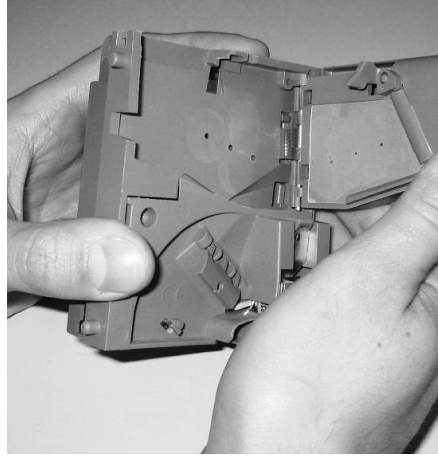

(b) Fig. 2

If the coin validator is still inefficient after cleaning do not hesitate to contact our hotline.



JCM UBA-10-SS Bill Acceptor maintenance

18



Periodical Cleaning

Depending on its environment and amount of use, the UBA bill acceptor may require routine maintenance to restore optimum performance.

Under normal use, the UBA bill acceptor should be checked every 2 to 3 months. For unusual operating conditions, such as when the UBA bill acceptor is exposed to a smoky environment, dirt, dust, water spray, airborne oil, and/or sand, more frequent maintenance will be required.

Cleaning Process

1. Switch off the gaming machine and open main and display door
2. Open the bill acceptor by pulling the blue clips.

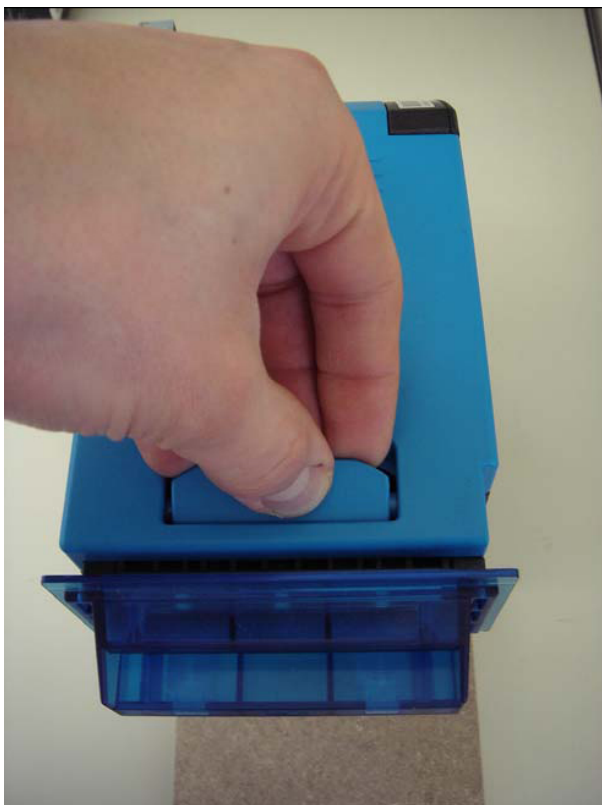

Please use a soft and lint-free cloth dampened with a weak solution of washing liquid and water and clean the following areas:

The upper and lower note paths, the belts, the top and bottom pinch wheels of note path.

Please do NOT use!

- Sharp or abrasive tools
- Compressed air
- Alcohol





MEI Cashflow SC83 Bill Acceptor maintenance

19

According to the manufacturer MEI no maintenance is required.



Astro GBA HR1 Bill Acceptor Maintenance



Periodical Cleaning

Depending on the environment and amount of use, the HR1 currency validator may require routine maintenance to restore optimum performance.

Under normal use, the currency validator should be checked every **2 to 4 months**.

For unusual operating conditions, such as when the currency validator is exposed to a smoky environment, dirt, dust, water spray, airborne oil, and/or sand, more frequent maintenance is required.



Cleaning Process

1. Switch off the gaming machine and open main and display door
2. Open the bill acceptor by squeezing the two purple clips and opening the unit.

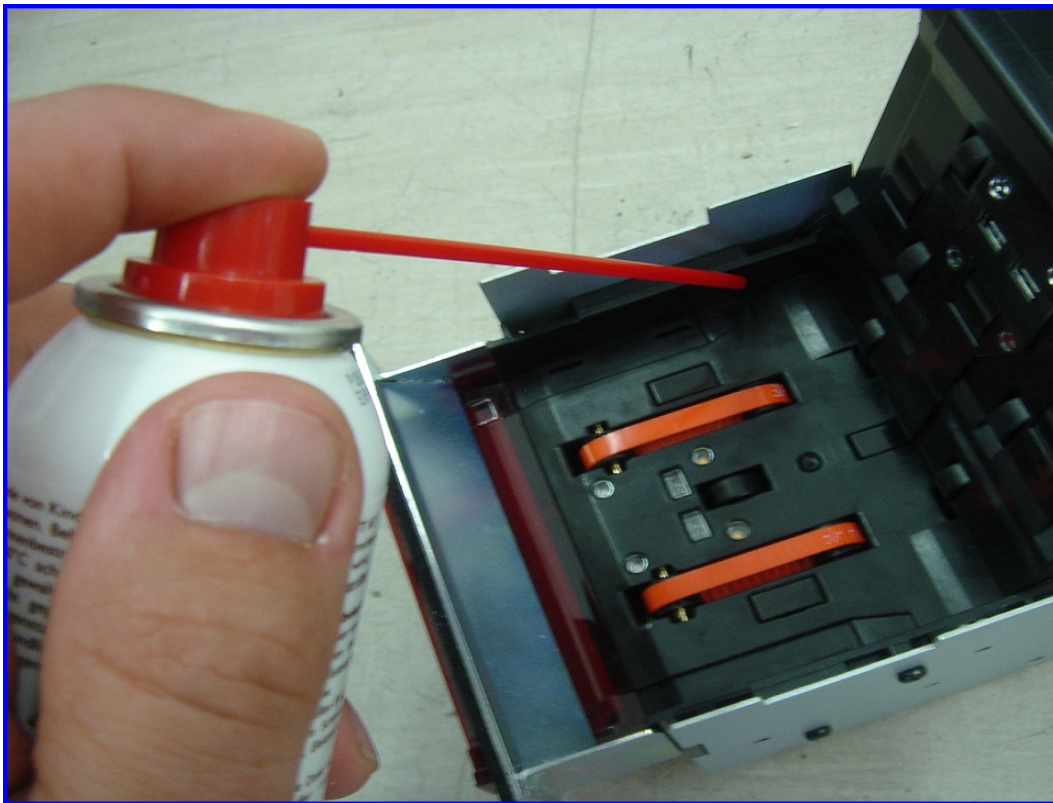
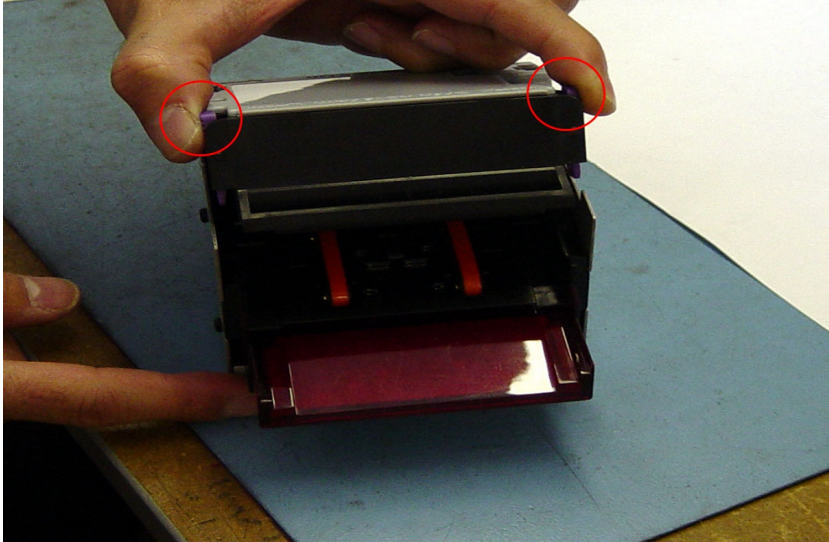

Use the provided compressed air (under compliance of the instruction -> do NOT rotate the spray more than 30°) to blow away any debris from the surface area of the note path making sure you clean out any dirt from the OASG lens apertures.



Please use a soft, lint-free cloth dampened with a weak solution of washing fluid and water to clean the following areas...

Wipe the upper and lower note paths, the belts, and the top and bottom pinch wheels of note path.

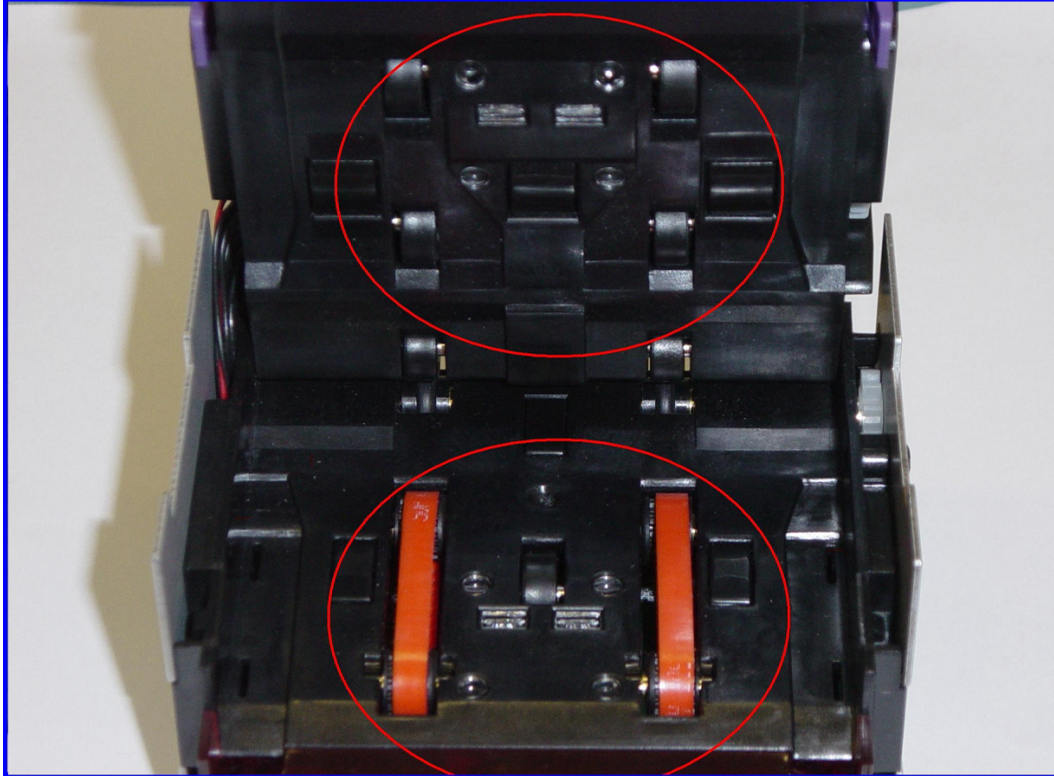

To rotate the belts for cleaning turn the gear at the rear of the validator.

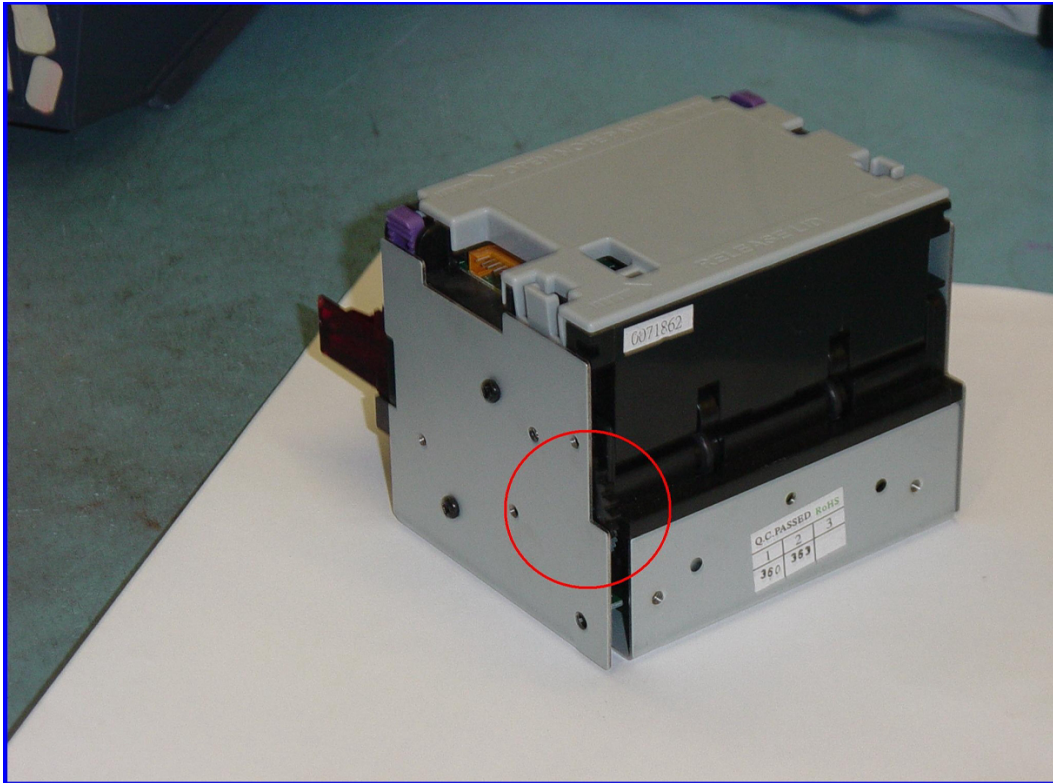

Ithaca Epic 950™ ticket printer – paper load and maintenance

21.1 Loading Tickets into Feeding Mechanism

When loading new ticket stacks, be sure that there is power to the printer.

The first ticket of the stack must be inserted into the printer by hand.

The printer's ticket tray is integrated with a guide to direct the ticket into the printer mechanism. Once the leading ticket enters the Top of Form sensor, the ticket will be automatically fed into the Printer Mechanism.

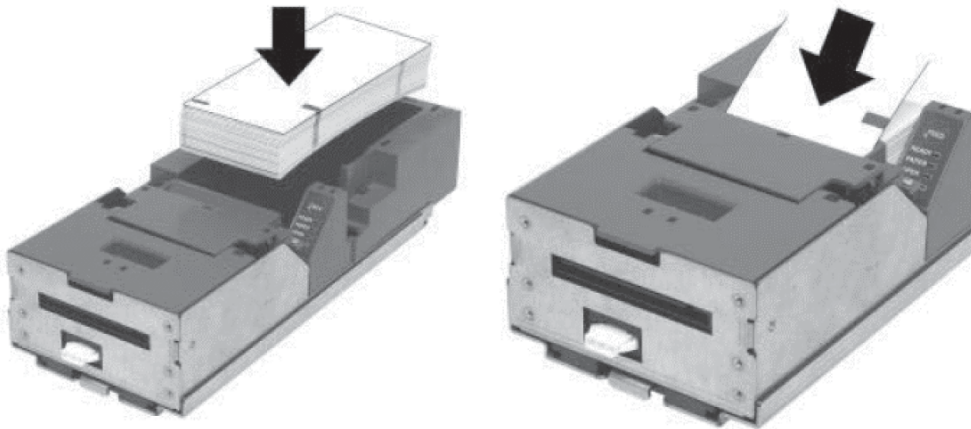

Loading tickets into the ticket supply train, making sure that the Black Dot is positioned as shown.



21.2 Removing Loaded Tickets (paper jam)

There are two ways to remove unused tickets:

1. The first way is to release the Ticket Cover by lifting and rotating backwards, this will relieve pressure to the platen and ticket can be removed.
This will also allow an opening that provides space to check the ticket for printer jams, or prepare the paper path for ticket replenishing
2. The second way is to use the feed button, which will feed out tickets from within the printer mechanism

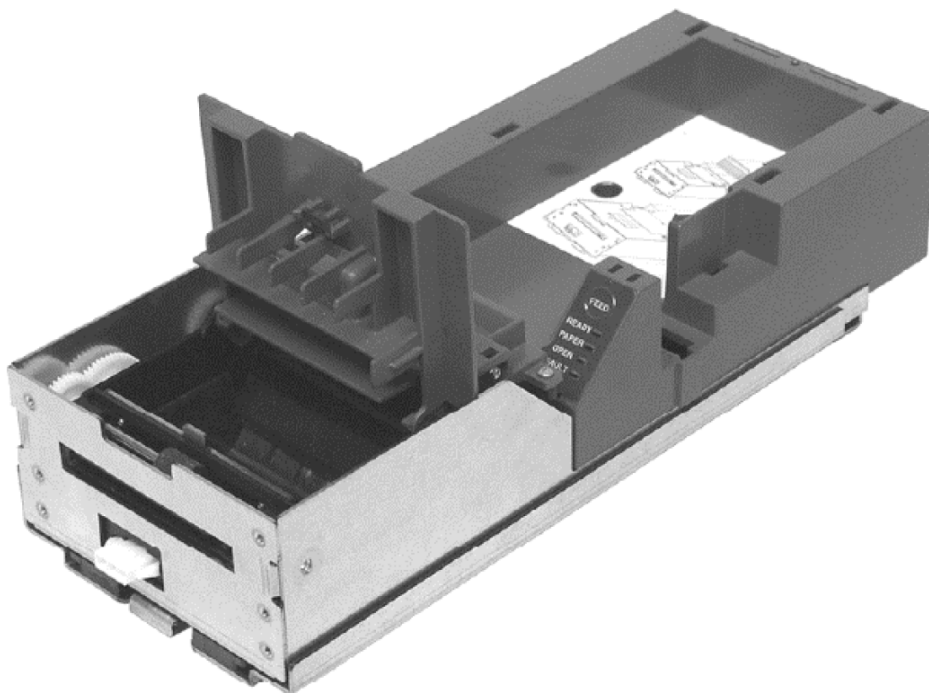

21.3 Cleaning the Printer Head

Two kinds of periodical cleaning operations will ensure continued high print quality from your printer:

1. Paper dust removal.
Use a soft brush to clean die paper dust from inside the printer and chassis area. The paper dust should also be removed from the sensor optics.
2. Cleaning thermal printer head.
If streaking on the printer ticket is evident, the thermal print header may need to be cleaned. This can be done by inserting a thermal printer cleaning card, as show in the instructions below:



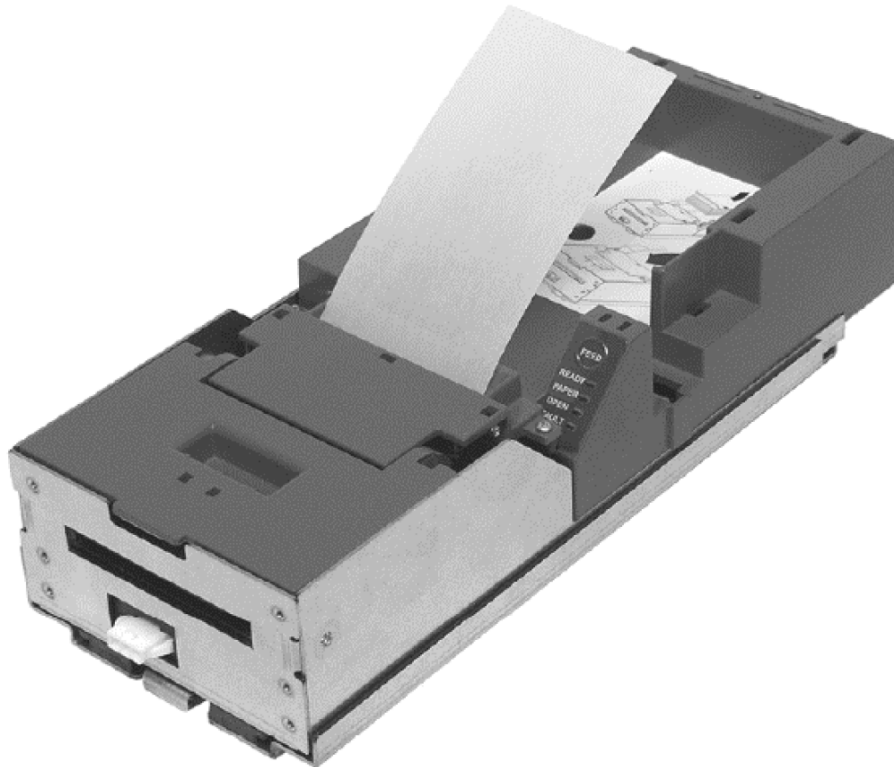

Detailed instructions

1. Open the cover and remove all tickets from ticket feed path.
2. Close the cover
3. Open cleaning card pouch and remove cleaning card.
4. Insert cleaning card into feed path.
5. The cleaning card will automatically be drawn into the feed path.
6. Open the cover and then remove the cleaning card by gently pulling it back.
7. Repeat process if necessary.
8. Properly dispose of used cleaning card.

Purchasing Cleaning Cards

Cleaning cards are available through TransAct by telephone or the Internet. 2.5" x 6" Thermal Cleaning Card (box of 25); Part number 100-03322 (TransAct)



Azkoyen - Hopper Rode U II Plus Maintenance



Periodical Cleaning

- General cleaning of the apparatus after 500,000 coin extraction
- It is recommended to clean the coin exit area, where the optic sensors are, more frequently.

Cleaning Process

1. Open the 2 screws as shown below.
2. Cleaning of the optic sensors can be done with cotton wool bud dipped in alcohol.



Warning

- Never use products that contain benzene hydrocarbons. These products severely degenerate the plastic parts producing irreparable damage.
- Never submerge the hopper in any liquid.

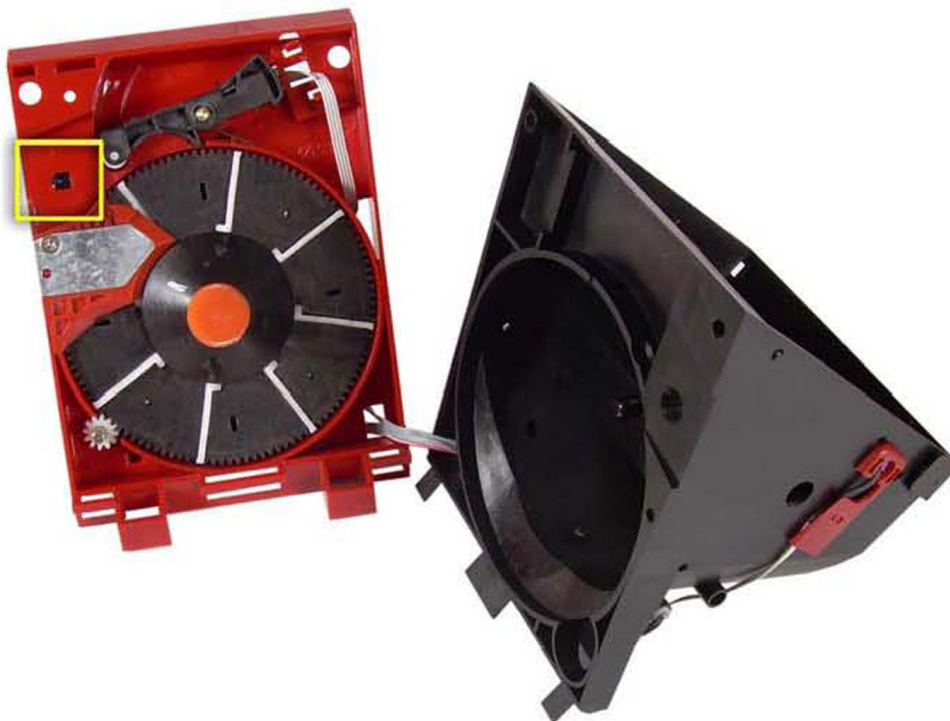
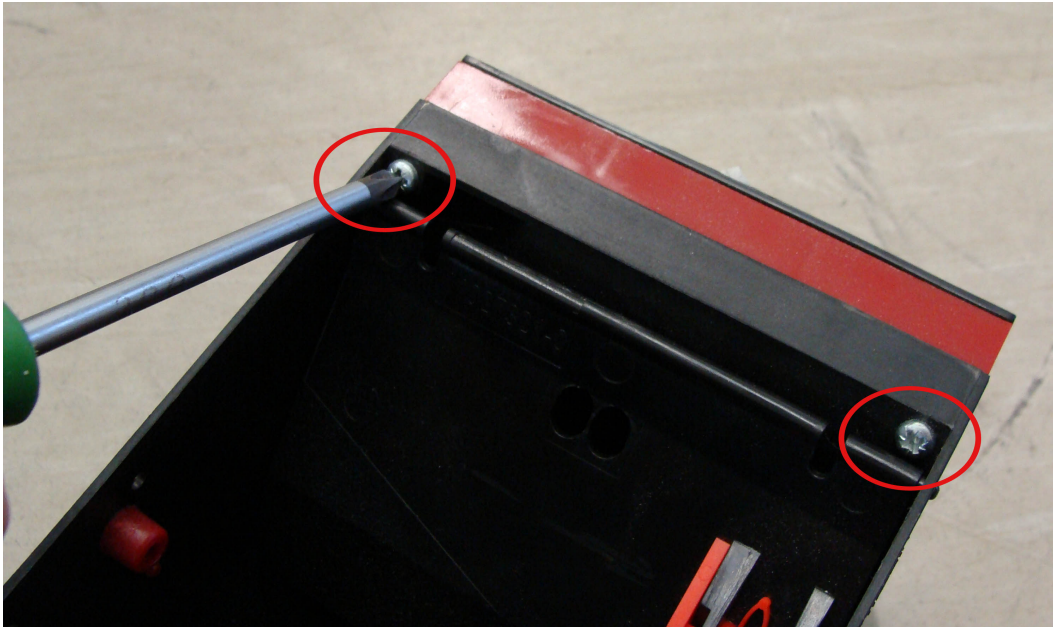

Replacing Coin or Bill acceptor

If a coin acceptor or a bill acceptor has to be changed in case of malfunction or bad performance, please proceed with the following steps:

1. switch off machine
2. replace the acceptor
3. switch on machine
4. check the coin or note settings in the Configuration settings menu - Hardware settings - Coin / Note acceptor (see chapter 9.4, page 22)
5. test the new acceptor in the test mode of the Operator menu (see chapter 10.2, page 29)

Note:

If the new coin acceptor has additional coin channels, these channels are disabled and can be enabled in the Configuration settings menu



Declaration of CE conformity

24



Declaration of CE conformity

Document-no.: QZ/1000/056/01/280306

Producer: TAB AUSTRIA
Industrie- und Unterhaltungselektronik GmbH & Co KG

Address: Haiderstraße 40
A-4052 Ansfelden
Tel.no.: 07229/78040, Fax-no.: 07229/78660

Description of good: Slotmaschine
Type: Golden Island NEVADA II

This mentioned product corresponds to the following European Regulations:

Criterion: 73/23/EWG
Criterion of the council for the adaptation of the legal regulations of the member states, concerning electrical working founds for using within limited tension bounds, changed by RL 93/68/EWG.

Criterion: 89/336/EWG
Criterion of the council for the adaptation of the legal regulations of the member states, concerning the electromagnetic compatibility changed by RL 91/263/EWG, 92/31/EWG, 93/68/EWG and 93/97/EWG.

The conformity of the mentioned product with the regulations of the criterions is shown through the observance of the relevant sections of the following norms:

Matched European norms:	Document	Issuing date
	EN 55022	1998
	EN 55024	1998
	EN 60950	2000
	EN 61000-3-2	2000
	EN 61000-3-3	2000

Issued by: GF

Managing Director: Ing. Siegfried Dattl jun.

Place, date: Ansfelden, June 20th 2007

Legally binding signature:



Industrie- und Unterhaltungselektronik GmbH & CoKG
A-4052 Ansfelden
Haiderstraße 40
Tel. +43 (0)7229/78040-0*
Fax +43 (0)7229/78660
www.tab.at, sales@tab.at

The declaration certifies the conformity with the mentioned criterions, but it doesn't include the assurance of characteristics. The safety regulations of the delivered goods have to be read through carefully.



End-User License Agreement for Microsoft Software

IMPORTANT - READ CAREFULLY:

This End-User License Agreement („EULA“) is a legal agreement between you (either an individual or a single entity) and the manufacturer („Manufacturer“) or the special purpose computing device („SYSTEM“) you acquired which includes certain Microsoft software product(s) installed on the SYSTEM („SOFTWARE PRODUCT“ or „SOFTWARE“). The SOFTWARE includes computer software, the associated media, any printed materials, and any „online“ or electronic documentation. By installing, copying or otherwise using the SOFTWARE, you agree to be bound by the terms of this EULA. If you do not agree to the terms of this EULA, Manufacturer and Microsoft Corporation („Microsoft“) are unwilling to license the SOFTWARE to you. In such event, you may not use or copy the SOFTWARE, and you should promptly contact Manufacturer for instructions on return of the unused product(s) for a refund.

SOFTWARE LICENSE

The SOFTWARE is protected by copyright laws and international copyright treaties, as well as other intellectual property laws and treaties. The SOFTWARE is licensed, not sold.

1. GRANT OF LICENSE. This EULA grants you the following rights:

- **Software.** You may use the SOFTWARE as installed on the System.
- **Application Sharing.** The SOFTWARE may contain technology that enables applications to be shared between two or more SYSTEMS, even if an application is installed on only one of the SYSTEMS. You should consult your application license agreement or contact the application licensor to determine whether sharing the application is permitted by its licensor.
- **Storage/Network Use.** If the SOFTWARE PRODUCT is installed on the SYSTEM over an internal network from a server, you must acquire and dedicate a license for the SOFTWARE PRODUCT for each SYSTEM on which the SOFTWARE PRODUCT is used or to which it is distributed. A license for the SOFTWARE PRODUCT may not be shared or used concurrently on different SYSTEMS.
- **Back-up Copy.** If MANUFACTURER has not included a copy of the SOFTWARE on separate media with the SYSTEM, you may make a single copy of the SOFTWARE for use solely for archival purposes with the SYSTEM.

2. DESCRIPTION OF OTHER RIGHTS AND LIMITATIONS.

- **Limitation on Reverse Engineering, De-compilation and Disassembly.** You may not reverse engineer, decompile, or disassemble the SOFTWARE, except and only to the extent that such activity is expressly permitted by applicable law notwithstanding this limitation.



- **Single SYSTEM.** The SOFTWARE is licensed with the SYSTEM as a single integrated product. The SOFTWARE may only be used with the SYSTEM.
- **Rental.** You may not rent or lease the SOFTWARE.
- **Software Transfer.** You may permanently transfer all of your rights under this EULA only as part of a sale or transfer of the SYSTEM, provided you retain no copies, you transfer all of the SOFTWARE (including all component parts, the media, any upgrades or backup copies, and this EULA, and if applicable, the Certificate(s) of Authenticity), and the recipient agrees to the terms of this EULA. If the SOFTWARE is an upgrade, any transfer must include all prior versions of the SOFTWARE.
- **Termination.** Without prejudice to any other rights, Manufacturer or Microsoft may terminate this EULA if you fail to comply with the terms and conditions of this EULA. In such event, you must destroy all copies of the SOFTWARE and all of its component parts.
- **Single EULA.** The package for the SOFTWARE may contain multiple versions of this EULA, such as multiple translations and/or multiple media versions (e.g., in the user documentation and in the software). In this case, you are only licensed to use one (1) copy of the SOFTWARE PRODUCT.

3. UPGRADES AND RECOVERY MEDIA.

- If the SOFTWARE is provided by Manufacturer on media separate from the SYSTEM and is labeled „For Upgrade Purposes Only“ (Upgrade SOFTWARE), you may install one copy of the Upgrade SOFTWARE onto the SYSTEM as a replacement copy for the SOFTWARE originally installed on the SYSTEM and use it in accordance with Section 1 of this EULA. You may also install additional copies of the Upgrade SOFTWARE as replacement copies onto additional SYSTEMS which are the same brand and model as the SYSTEM and contain a duly licensed copy of the same version and language release of the SOFTWARE („ADDITIONAL SYSTEMS“), provided that (1) Manufacturer has supplied a corresponding serialized sticker for each additional copy of the Upgrade SOFTWARE, and (2) you affix a serialized sticker per Manufacturer’s instructions for each unit of Upgrade SOFTWARE you install.
- If the SOFTWARE is provided by Manufacturer on separate media and labeled as „Recovery Media“, you may not make a copy of the SOFTWARE as described in Section 1 for archival purposes. Instead, you may use the Recovery Media solely to restore or reinstall the same version and language release of the SOFTWARE as originally installed on the SYSTEM and thereafter use the SOFTWARE as restored or reinstalled in accordance with Section 1 of this EULA. A single unit of Recovery Media may be used by you to restore or reinstall the SOFTWARE on ADDITIONAL SYSTEMS.

4. COPYRIGHT.

- All title and copyrights in and to the SOFTWARE (including but not limited to any images, photographs, animations, video, audio, music, text and „applets“, incorporated into the SOFTWARE), the accompanying printed materials, and any copies of the SOFTWARE, are owned by Microsoft or its suppliers. You may not copy the printed materials accompanying the SOFTWARE. All rights not specifically granted under this EULA are reserved by Microsoft.



5. PRODUCT SUPPORT.

- Product support for the SOFTWARE is not provided by Microsoft or its subsidiaries. For product support, please refer to Manufacturer's support number provided in the documentation for the SYSTEM. Should you have any questions concerning this EULA, or if you desire to contact Manufacturer for any other reason, please refer to the address provided in the documentation for the SYSTEM.

6. LIMITED WARRANTY.

- **Limited Warranty.** Manufacturer warrants that the SOFTWARE will perform substantially in accordance with the accompanying written materials for a period of ninety (90) days from the date of receipt. Any implied warranties on the SOFTWARE are limited to ninety (90) days. Some states/jurisdictions do not allow limitations on duration of an implied warranty, so the above limitation may not apply to you.
- **Customer Remedies.** Manufacturer's and its suppliers' entire liability and your exclusive remedy shall be, at Manufacturer's option, either (a) return of the price paid, or (b) repair or replacement of the SOFTWARE that does not meet the above Limited Warranty and which is returned to Manufacturer with a copy of your receipt. This Limited Warranty is void if failure of the SOFTWARE has resulted from accident, abuse, or misapplication. Any replacement SOFTWARE will be warranted for the remainder of the original warranty period or thirty (30) days, whichever is longer.
- **No Other Warranties.** EXCEPT AS EXPRESSLY PROVIDED IN THE LIMITED WARRANTY SECTION ABOVE, THE SOFTWARE IS PROVIDED TO THE END USER „AS IS“ WITHOUT OF ANY KIND, EITHER EXPRESSED OR IMPLIED, INCLUDING, BUT NOT LIMITED TO, WARRANTIES OF NON-INFRINGEMENT, MERCHANTABILITY, AND/OR FITNESS FOR A PARTICULAR PURPOSE. THE ENTIRE RISK OF THE QUALITY AND PERFORMANCE OF THE SOFTWARE IS WITH YOU.
- **No Liability for Consequential Damages.** MANUFACTURER'S SUPPLIERS SHALL NOT BE HELD TO ANY LIABILITY FOR ANY DAMAGES SUFFERED OR INCURRED BY THE END USER (INCLUDING, BUT NOT LIMITED TO, GENERAL, SPECIAL, CONSEQUENTIAL OR INCIDENTAL DAMAGES INCLUDING DAMAGES FOR LOSS OF BUSINESS PROFITS INTERRUPTION, LOSS OF BUSINESS INFORMATION AND THE LIKE), ARISING FROM OR IN CONNECTION WITH THE DELIVERY, USE OR PERFORMANCE OF THE SOFTWARE.

Note on Java Support

THE SOFTWARE PRODUCT MAY CONTAIN SUPPORT FOR PROGRAMS WRITTEN IN JAVA. JAVA TECHNOLOGY IS NOT FAULT TOLERANT AND IS NOT DESIGNED, MANUFACTURED, OR INTENDED FOR USE OR RESALE AS ON-LINE CONTROL EQUIPMENT IN HAZARDOUS ENVIRONMENTS REQUIRING FAIL-SAFE PERFORMANCE, SUCH AS IN THE OPERATION OF NUCLEAR FACILITIES, AIRCRAFT NAVIGATION OR COMMUNICATION SYSTEMS, AIR TRAFFIC CONTROL, DIRECT LIFE SUPPORT MACHINES, OR WEAPONS SYSTEMS, IN WHICH THE FAILURE OF JAVA TECHNOLOGY COULD LEAD DIRECTLY TO DEATH, PERSONAL INJURY, OR SEVERE PHYSICAL OR ENVIRONMENTAL DAMAGE.



Warranty terms by TAB-Austria GmbH & CoKG

(Tab hereinafter)

We are granting a warranty for this machine under the following conditions:

Insofar as the „General Terms of Business of TAB-AUSTRIA Industrie- und Unterhaltungselektronik GmbH & Co KG“ are not modified by the following, which sets out the conditions and scope of our warranty performance, these terms will continue to apply without change.

The warranty period for our products from delivery is:

- *24 months for all Silverball Terminals*
 - Silverball Strato
 - Silverball Strato Max
 - Silverball Cosmo
 - Silverball Cosmo Max
 - Silverball Pro
 - Silverball Max Pro
 - Silverball Beetle Pro
 - Silverball Beetle Max Pro
- *24 months for*
 - Max Fire
 - Max Fire Video
 - Virtual Pinball
 - Golden Island
 - Fun4Four
- *12 months for*
 - all other products, particularly betting terminals
- *Six months*
 - for all spare parts
however, if a warranty period of more than six months still obtains for the machines, this period will apply in its entirety to the spare part.



The warranty will only be granted for new products by TAB, not for their spare parts, not for products of different brands and manufacturers and corresponding spare parts. No warranty is granted for used products either.

In accordance with the following provisions, we shall repair defects to the machine that have been demonstrably caused by a material and/or manufacturing fault which already existed at the time the product was handed over, and which was reported within 14 days of it becoming apparent to our sales partner or the first end user while still within the warranty period. No warranty is assumed for used machines.

The warranty exclusively covers such components that are essential to operating the product. It does not include easily damaged parts or wearing parts, such as, for example, glass, plastic or light bulbs. Minor deviations from the desired composition insignificant to the value and usability of the machine will not result in any warranty obligations. Damage caused by physical, chemical, electrical or electrochemical or other effects not related to the customary dedicated use will not result in any warranty obligations; neither does damage caused by water or abnormal environmental conditions or inappropriate operating conditions. Also, no warranty can be assumed for machine defects caused by transport damage for which we are not responsible, incorrect installation and assembly, incorrect use, non-observance of operating or assembly instructions or lack of care.

The warranty claim becomes void if repairs or interventions have been carried out by the customer himself/herself or by persons who were not accordingly authorized or who were not authorized by us or in the event of our machines being fitted with spare, supplementary or accessory parts that are not original parts, or if parts have been removed.

The warranty performance will be made in such a way that defective components will at our discretion be repaired or replaced with faultless components free of charge unless improvement or exchange are impossible or would result in for us unreasonable cost. In such cases, a reduction in price or, in the event of not only a minor defect, cancellation of sale may be claimed.

Machines for which a warranty performance is being claimed on the basis of this warranty must be handed over or sent to us. Repairs at the installation site are not possible. The customer will bear transport costs and the transport risk.

Exchanged parts will become our property.

Warranty performances will neither result in an extension of the warranty period nor will they initiate a new warranty period.

Further or other claims (in particular claims for damages suffered beyond the machine) are excluded insofar as liability is not mandatory by law. These warranty terms apply to machines purchased and operated in Austria. They apply to machines conveyed to other countries only insofar as they possess the technical requirements (e.g. voltage, frequency, etc.) for the corresponding country, have been officially approved for use there and are suited to the individual climate and environmental conditions.



The TFT LCD display consists of more than 1,000,000 Thin-Film Transistors (TFT). A small amount of missing, black, or luminous points is characteristic for TFT LCD technology. The warranty performance will be granted if more than 15 missing, black, or luminous points are present.



In case of any irregularities in the machine, please check power and all plug-in connections!

In case you cannot remove an error, please call our hotline:

Call +43-7229-780-40 ext. 250



Notes

27



